

NUMERACY

Y8

Procedural
sample
materials

National Numeracy Tests



Llywodraeth Cymru
Welsh Government

Procedural sample materials: Guidance for teachers

The procedural tests will be first introduced in schools in 2013. Sample items have been produced for each year group to illustrate different question types and formats for response.

The sample items are closely aligned to the numeracy framework and are representative of the anticipated level of demand. However, they are not complete papers: the number of marks within the tests next summer will range from about 28 for the lower year groups to about 36 for older learners. Each test will last 30 minutes.

- *How to use the sample items*

The sample items can be printed and used for practice before the tests. Strengths and areas for improvement can then be identified and used to provide additional classroom learning and teaching activities, where appropriate.

The procedural sample items can also be used as a basis for classroom discussion, to illustrate good test techniques. These include the importance of reading the question carefully, where to write the answers, the relevance of showing working to gain partial credit, good time management and the benefits of checking answers.

Teachers may wish to support learners by discussing different approaches towards 2 mark items. For example, teachers could anonymise and photocopy a range of responses and ask learners to work in small groups to rank from 'best' to 'worst', identifying what is good about each and why.

- *Marking of the sample items*

A markscheme is provided, which is typical of those to be used alongside the live tests. It is designed to be quickly and fairly applied with clear guidance on when and how partial credit should be applied. General marking guidance provides principles of marking to facilitate consistency across schools.

1

$$\boxed{} + 12.6 = 20$$

$$2000 - 526 = \boxed{}$$

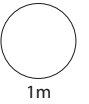
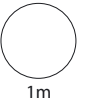

2

$$18 - (7 + 3) \div 2 = \boxed{}$$

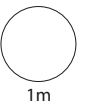

3

Cherries

100g costs £1.25



How much for 3kg?



\pounds

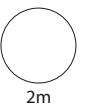

4 Increase 90 by 10%

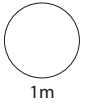

5

Favourite sports

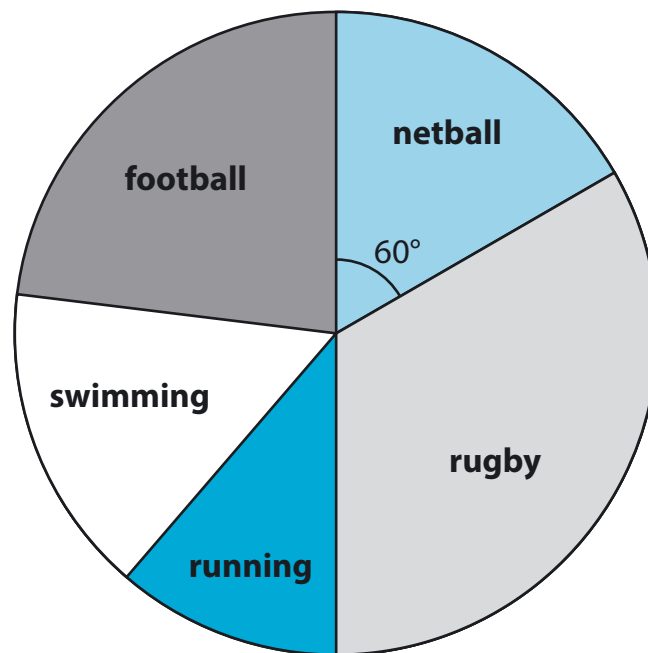

10 children voted for netball.

How many voted for rugby?

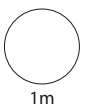

How many voted altogether?

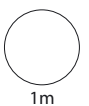

6

$$12 \times 0.3 = \boxed{}$$

$$4.5 \div 9 = \boxed{}$$

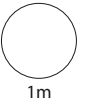

1m

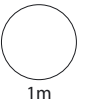

1m

7

Biscuits
3 packets
for the price of 2

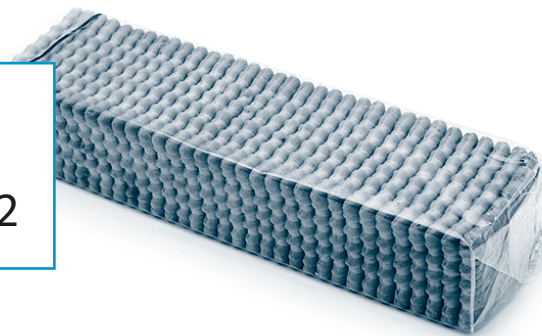

1 packet costs £1.15

How much for 9 packets?



£

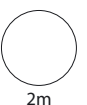

2m

8 Work out 264×34

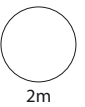

9 Write $\frac{1}{8}$ as a decimal.

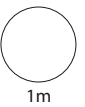

Write 35% as a fraction.

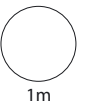

10 Work out the **volume** of the cube.

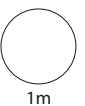
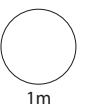
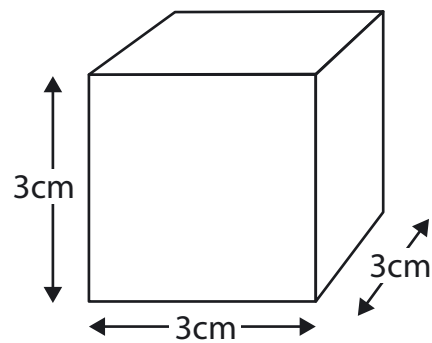

11 Round 256.34505 to two decimal places.

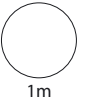

12 Work out $\frac{3}{4} - \frac{1}{3}$

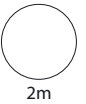

13

Profit from car boot sale



Shared
5:2



Sita gets £30

How much does Rhys get?

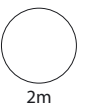

Procedural sample materials: Marking guidance

It is important that the tests are marked accurately. The questions and answers below help to develop a common understanding of how to mark fairly and consistently.

- ***Must learners use the answer boxes?***

Provided there is no ambiguity, learners can respond anywhere on the page. If there is more than one answer the one in the answer box must be marked, even if incorrect. However, if the incorrect answer is clearly because of a transcription error (e.g. 65 has been copied as 56), mark the answer shown in the working.

- ***What if learners use a method that is not shown within the markscheme?***

The markschemes show the most common methods, but alternative approaches may deserve credit – use your best judgement. Any correct method, however idiosyncratic, is acceptable.

- ***Does it matter if the learner writes the answer differently from that shown in the markscheme?***

Numerically equivalent answers (e.g. eight for 8, or two quarters or 0.5 for half) should be marked as correct unless the markscheme states otherwise.

- ***How should I mark answers involving money?***

Money can be shown in pounds or pence, but a missing zero, e.g. £4.7, should be marked as incorrect.

- ***How should I mark answers involving time?***

In the real world, specific times are shown in a multiplicity of ways so accept, for example, 02:30, 2.30, half past 2, etc. Do not accept 2.3 as this is ambiguous. The same principle should be used for marking time intervals, e.g. for two and a half hours accept 2.5 but not 2.5pm.

- ***What if the method is wrong but the answer is correct?***

Unless the markscheme states otherwise, correct responses should be marked as correct even if the working is incorrect as learners may have started again without showing their revised approach).

- ***What if the learner has shown understanding but has misread information in the question?***

For a two (or more) mark item, if an incorrect answer arises from misreading information given in the question and the question has not become easier as a result then deduct one mark only. For example, if the 2 mark question is 86×67 and the learner records 96×67 then gives the answer 6432, one mark only should be given. In a one mark question, no marks can be given.

- ***What should I do about crossed out work?***

Working which has been crossed out and not replaced can be marked if it is still legible.

- ***What is the difference between a numerical error and a conceptual error?***

A numerical error is one in which a slip is made, e.g. within 86×67 the learner works out $6 \times 7 = 54$ within an otherwise correct response. A conceptual error is a more serious misunderstanding for which no method marks are available, for example if 86×60 is recorded as 516 rather than 5160

Year 8 Procedural sample materials: Markscheme

Q	Marks	Answer	Comments
1i	1m	7.4	
1ii	1m	1474	
2	1m	13	
3	2m	£37.50	
	Or 1m	37.5 or 30×1.25 seen (or $10 \times 3 \times 1.25$) Or 12.5(0) seen Or Correct method with only one numerical error	Example for 1m: $10 \times 1.25 = 12$ (error), $12 \times 3 = 36$
4	1m	99	
5i	1m	20	
5ii	1m	60	Do not allow follow through
6i	1m	3.6	
6ii	1m	0.5	
7	2m	£6.90	
	Or 1m	6.9 or 6 seen Or 3 packets linked to £2.30 seen Or Correct method with only one numerical error	Examples for 1m: $9 \div 3 \times 2 \times 1.15 = \text{£}6.80$ (error) 3 packets £2.40 (error), so 9 packets £7.20

Q	Marks	Answer	Comments
8	2m	8976	
	Or 1m	Correct method with only one numerical error	Example for 1m: $264 \times 30 = 6920$ (error), $264 \times 4 = 1056$, $6920 + 1056 = 7976$
9i	1m	0.125	Do not accept equivalent fractions
9ii	1m	$\frac{7}{20}$	Do not accept equivalent decimals
10i	1m	27	
10ii	1m	Units correct, i.e. cm^3	Accept unambiguous alternatives, e.g. cubic cm
11	1m	256.35	Do not accept equivalent fractions or decimals
12	2m	$\frac{5}{12}$	
	Or 1m	Shows fractions equivalent to the two given with common denominators, e.g. $\frac{9}{12}$ and $\frac{4}{12}$ Or Correct method with only one numerical error	Example for 1m: $\frac{9}{12} - \frac{3}{12}$ (error) = $\frac{6}{12}$
13	2m	£12	
	Or 1m	6 seen Or $30 \div 5$	

